

175-DIA

Precision tungsten carbide grinding and fine grinding machine



Technical data

Grinding wheels with double cup

Abrasive	Diamond
Diameter	175 mm (6.89")
Bore	20 mm (.787")

Spindle speed

2700 min⁻¹

Cutting speeds

Grinding wheels	24 m/s (4724ft/min)
Chip breaker wheels	14 m/s (2755ft/min)

Spindle bearings

Preloaded and matched precision ball bearings, life time lubricated

Tool feed

Manual with micrometer screw	Graduation: 0.01 mm (.0004")
------------------------------	------------------------------

Clearance angle setting

max. 26°

Clamping range of tool holders

Tools with rectangular shank	max. 40 x 40 mm (1.57 x 1.57")
Tools with round shank	max. Ø 16 mm (.63")
Circular form tools	max. Ø 35 mm (1.378")

Power requirement

1.7 kW

Motor performance

Drive motor	1.5 kW
Pump motor	0.1 kW

Coolant unit

Capacity of coolant tank	23 liters (5 gals)
Flow rate per nozzle	3.5 l/min (.77 gal/min)

Machine dimensions

incl. machine lamp 1000x600x1500mm (39.4x23.6x59")

Weight of the machine

300 kg (660 lb)

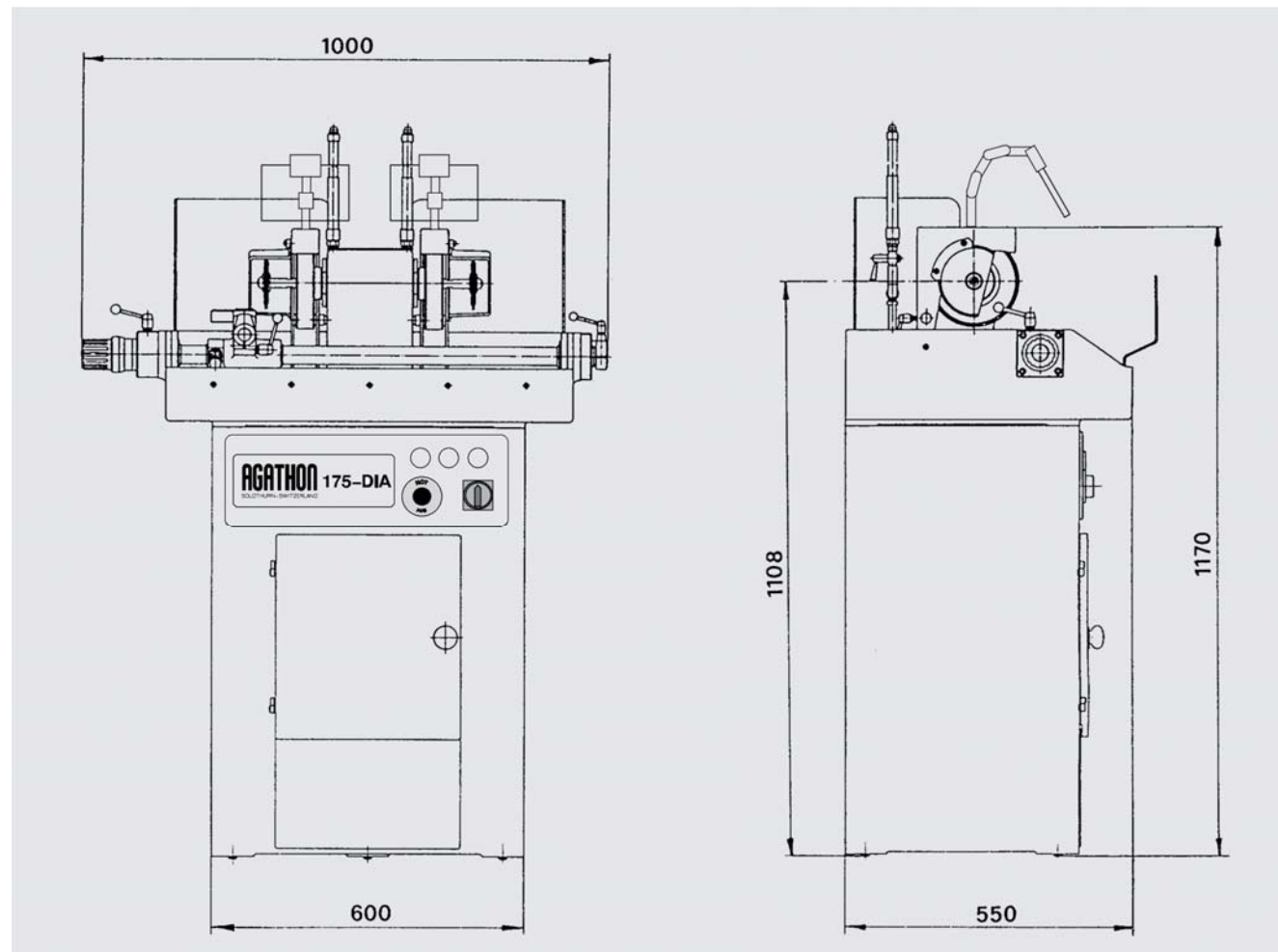

Precision tool grinding machine

Grinding advantages with AGATHON 175-DIA

All tungsten carbide tools are ground, geometrically correct and without undue generation of heat with diamond grinding wheels. The tungsten carbide machining with diamond grinding wheels requires a firm tightening of the tools and offers the following advantages:

- higher grinding accuracy
- minimal wheel wear
- reduced grinding costs
- no dressing of the grinding wheel
- cooler grinding
- improved tool life.

The tools are rough and finish ground with two double cup wheels of different grits and without unclamping in accordance with the proven AGATHON grinding method. By using the 2-wheel principle and clamping the tool firmly in a holder which can be tilted and inclined in all directions, the following is achieved:

- optimal and always constant cutting edge geometry
- cutting surfaces with the finest surface and thus perfect and sharp cutting edges
- good stock removal for shortest grinding times
- minimal and even wheel wear, therefore longer preservation of the original grinding wheel shape
- tool requires to be clamped only once.

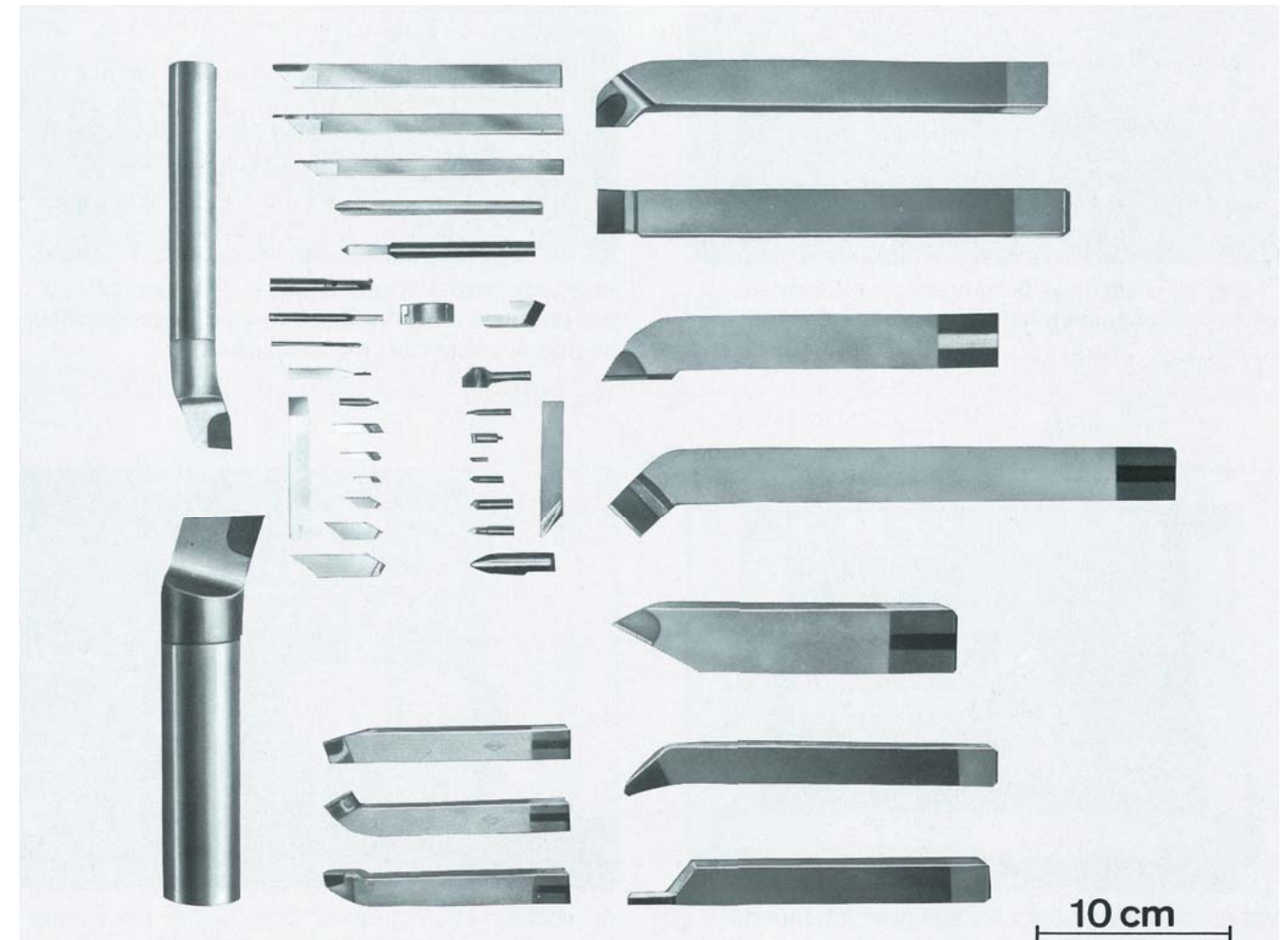

Special features

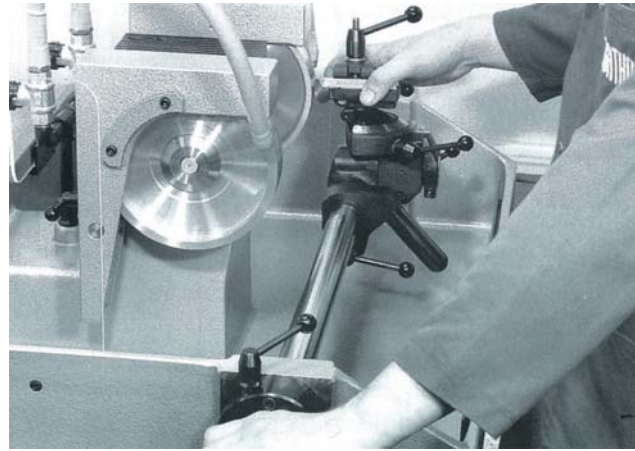

Mechanical fine infeed is applied with the left hand whilst oscillating the tool with the right hand

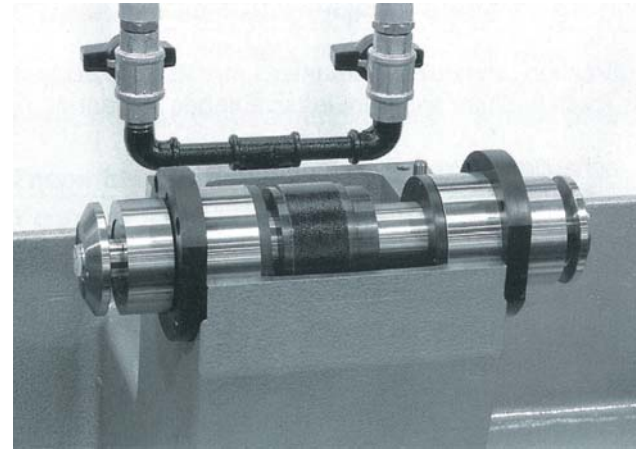

Easy assembly operation for belt or bearing replacement by removing the wheelhead top cover



The high capacity coolant pump is mounted directly on the pull-out coolant tank

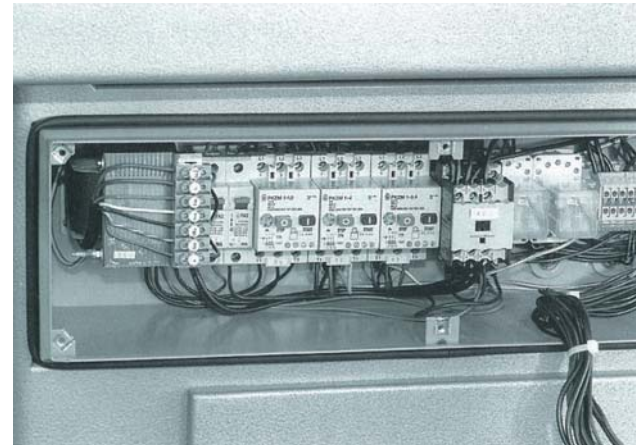

Simple mains connection in terminal box with built-in transformer and brake rectifier

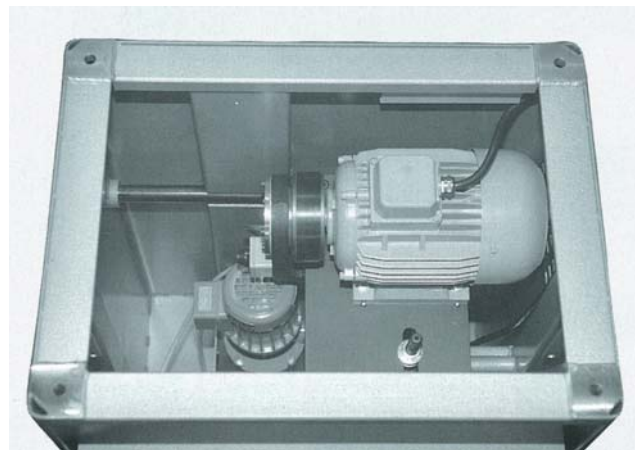

Main drive motor with belt tensioner and magnetic brake mounted in the machine base

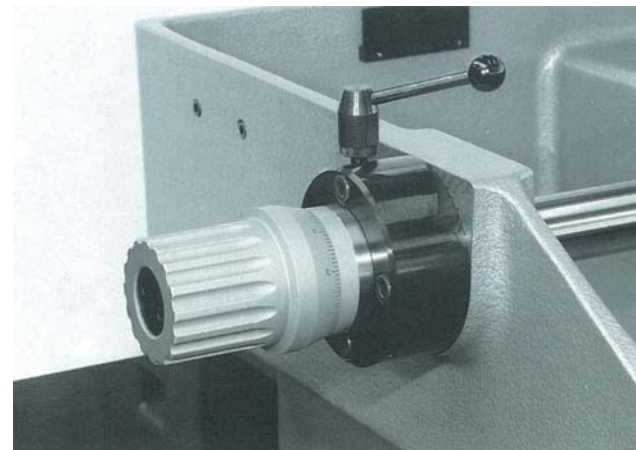

Micrometer fine infeed with fixed scale drum

Accessories with work examples

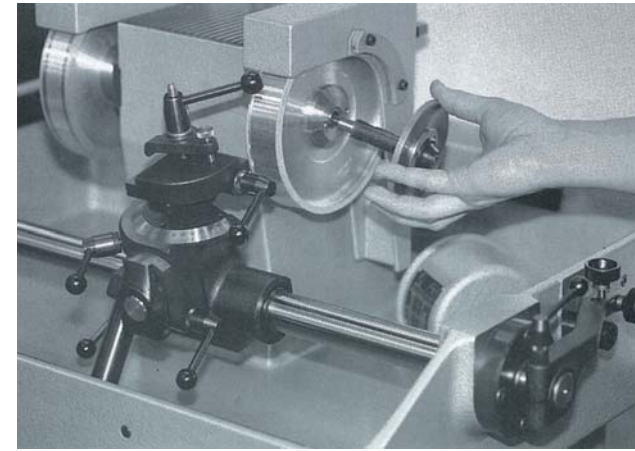

Installing the right hand extension arbor, item 4.04.17.10, with a chip breaker wheel



Rapid changeover of accessories. Tool holder 15, item 3.00.49.40, placed in basic adapter

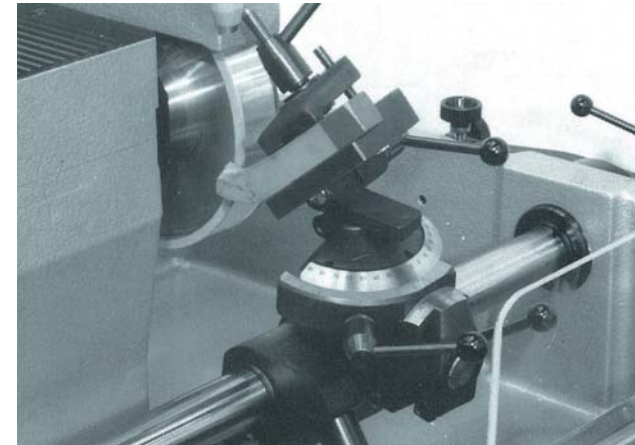

Chip breaker grinding on a cranked tool with inclinable tool holder 40, item 3.00.54.10



Off-hand radius grinding. Tool on grinding table, item 4.01.73.00



Effective 4-piece plexiglass splash guards, items 2.00.96.60, ...80



Our grinding wheels are specially selected to suit the specific grinding conditions

Accessories with work examples

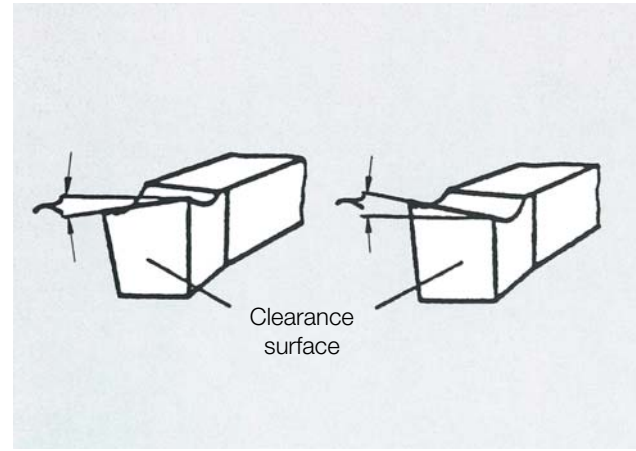
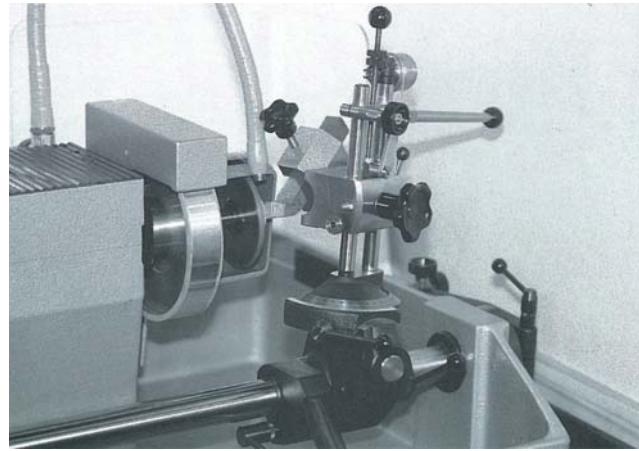

Chip-groove grinding attachment, item 200.29.30.0, for grinding straight-lined chip-groove with suitable radii for breaking or curling the produced chips, with weight compensation of the grinding motion

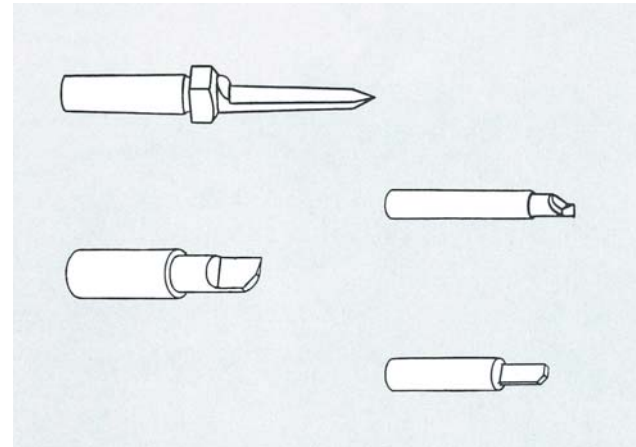
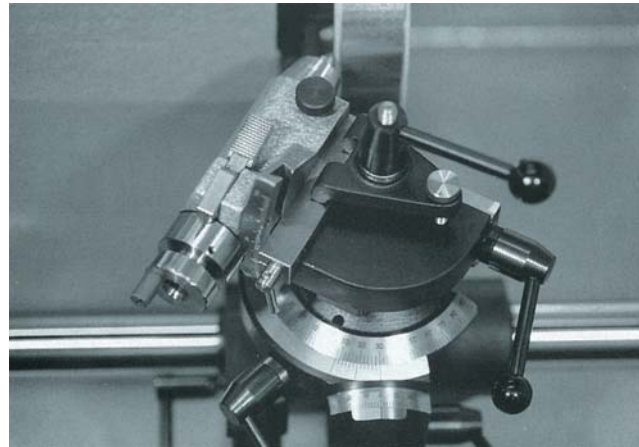

Cutter grinding attachment, item 3.00.55.40, for cylindrical and conical grinding. Multi-facet grinding with dividing disc, face and radial relief grinding, with **W15** collets

Spade drills and single lip cutters are clamped in the collet, ground to shape and size and cutting edges ground

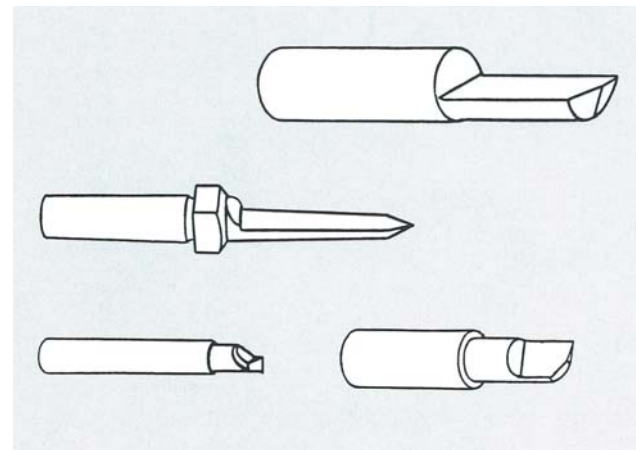

Cutter grinding attachment, item 401.82.50.0, for cylindrical and conical grinding. Multi-facet grinding with dividing disc, face and radial relief grinding, with **W20** collets

175-DIA F0034012 / Date: 22.10.2013 / Subject to technical modifications



Quality
Precision
Innovation. ■

Agency close to you:
<http://www.agathon.com>

AGATHON
S W I T Z E R L A N D



AGATHON AG, Maschinenfabrik

Postfach 332

CH-4512 Bellach

Tel +41 (0)32 617 4500

Fax +41 (0)32 617 4700

info@agathon.ch

www.agathon.ch

